

MAINTENANCE & OPERATING INSTRUCTIONS

For DIXON "BAYCO"
5300 SERIES
API RACK COUPLER
FOR CRUDE OIL
Model Numbers

5300BCFKM B SEALS, BONDED NOSE SEAL
5300BCL....FKM B SEALS, BONDED NOSE SEAL, LOCKABLE HANDLE

For Sales & Service Contact

USA:

Dixon Bayco USA
Chestertown, Maryland
Phone: 410-778-2000
Fax: 410-778-4702
Toll Free: 800-355-1991
E-mail: dixonbayco@dixonvalve.com
dixonbayco.com

Canada:

Dixon Group Canada Limited
Innisfil (Barrie), Ontario
Phone: 705-436-1125
Fax: 705-436-6251
Toll Free: 877-963-4966
E-mail: jsales@dixongroupcanada.com
canada.dixonvalve.com

Mexico:

Dixva, S. de R.L. de C.V.
Monterrey, N.L
Phone: 01-800-00-DIXON (34966)
Fax: 01-81-8354-8197
E-mail: contactenos@dixonvalve.com.mx
dixonvalve.com

Europe:

Dixon Group Europe Ltd
Preston, England
Phone: +44 (0)1772 323529
Fax: +44 (0)1772 314664
E-mail: enquiries@dixoneurope.co.uk
dixoneurope.co.uk

Asia Pacific:

Dixon (Asia Pacific) Pty Ltd
Wingfield, South Australia
Phone: +61 8 8202 6000
Fax: +61 8 8202 6099
E-mail: enquiries@dixonvalve.com.au
australia.dixonvalve.com



The Right Connection®

5300 SERIES API RACK COUPLER FOR CRUDE OIL

Bill of Materials

Qty of Components per Unit

Item #	Description	Part #	5300BC	5300BCL
1	Body	-	1	1
2	Body Dust Ring	112173	1	1
3	Sleeve Assembly	400684	1	1
4	Poppet	341833	1	1
5	Bent Link	112151	2	2
6	Bent Link Pin	391141	2	2
7	Bent Link Washer	112158	2	2
8	Cotter Pin	110721	2	2
9	Drive link	112148	1	1
10	Interlocking Cam	112147	5	5
11	Torsion Spring	112149	6	6
12	Nose Piece Dust Ring	Use kit 5354K28	1	1
13	O-Ring 2-350, Viton B	Use kit 5354K28	1	1
14	Bonded Nose Seal, Viton B	Use kit 5354K28	1	1
15A	Bearing	341834	1	N/A
15B	Bearing w/ Locking Hole	341868	N/A	1
16	PTFE U-Seal 220 (Optional)*	112163	1	1
17	O-Ring 2-220, Viton B	Use kit 5354K3 or 5354K4	1	1
18	PTFE U-Seal 212 (Optional)*	112162	1	1
19	O-Ring 2-212, Viton B	Use kit 5354K3 or 5354K4	2	2
20	Wave Spring Washer	112282	2	2
21	Bail	341788	1	1
22	Bail Spring	112150	2	2
23	Bail Pin	112175	2	2
24	Internal Retaining Ring	112176	2	2
25	Release	391139	1	1
26	Washer	111562	3	3
27	Cotter Pin	111563	3	3
28	Shaft	391140	1	1
29	Shaft Cotter Pin	112307	1	1
30	Spacer	391142	1	1
31A	Handle	341789	1	N/A
31B	Lockable Handle	400713	N/A	1
32	Shaft Outside Washer	112160	1	1
33	Shaft Inside Washer	112159	1	1
34	Clevis Pin	112500	1	1
35	Latch	112240	1	1

Repair Kits

Part #	Description	Includes item #
5354K3	Viton B shaft seal kit:	17, 19, 29, 32, 33
5354K4	Viton B shaft seal kit with optional PTFE U Seals:	16*, 17, 18*, 19, 29, 32, 33
5354K28	Viton B bonded nose seal kit:	12, 13, 14, 29
5354K23	Valve assembly repair kit	4, 5, 6, 7, 8, 9, 29, 32, 33

* Items 16 & 18 are optional PTFE U seals. When the U seals are added to the coupler they isolate the main rubber seals from the liquid being conveyed, thereby increasing the longevity of the rubber seals.

N/A = "Not Applicable"

API RACK COUPLER -5300BC/5300BCL

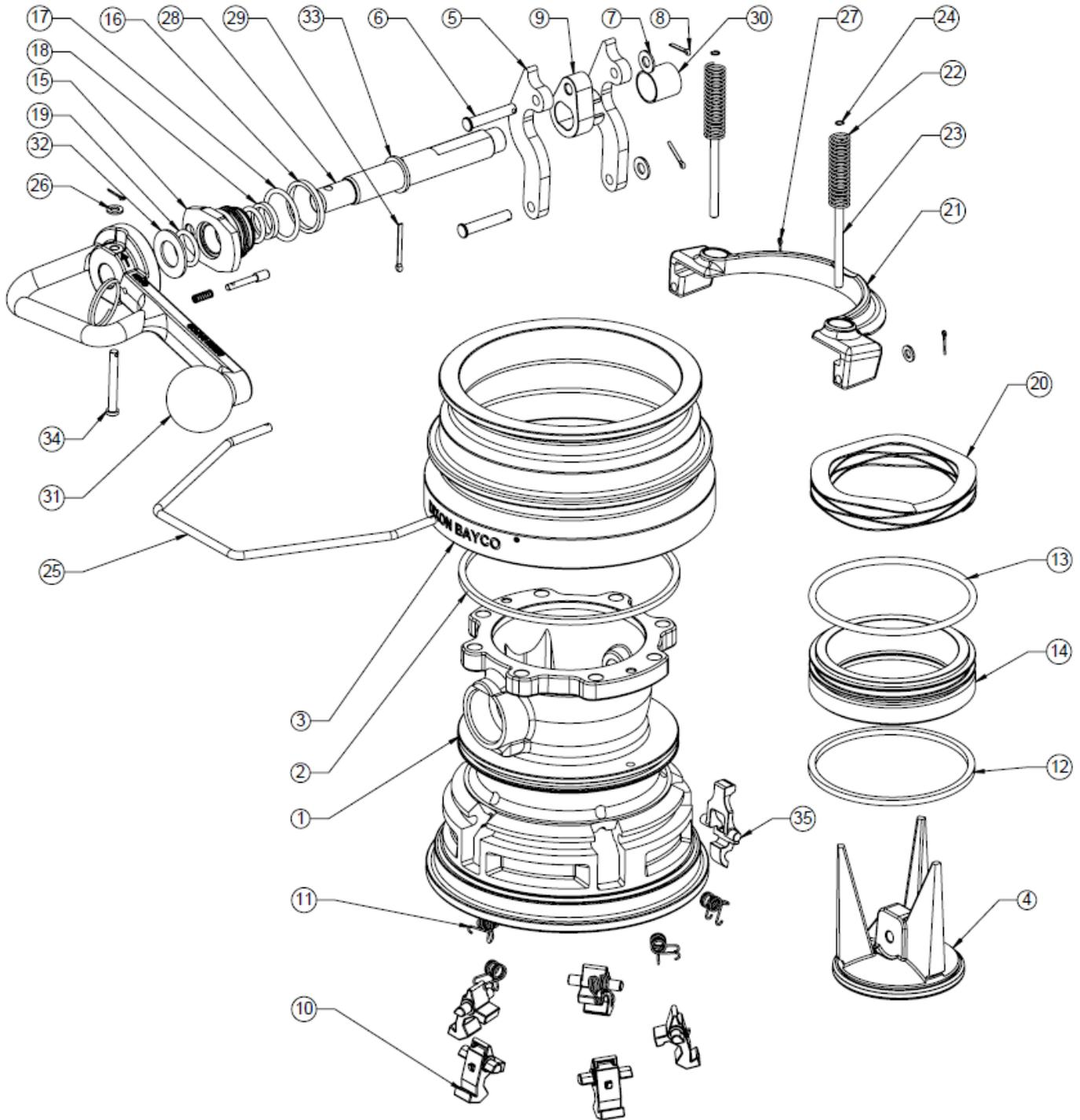

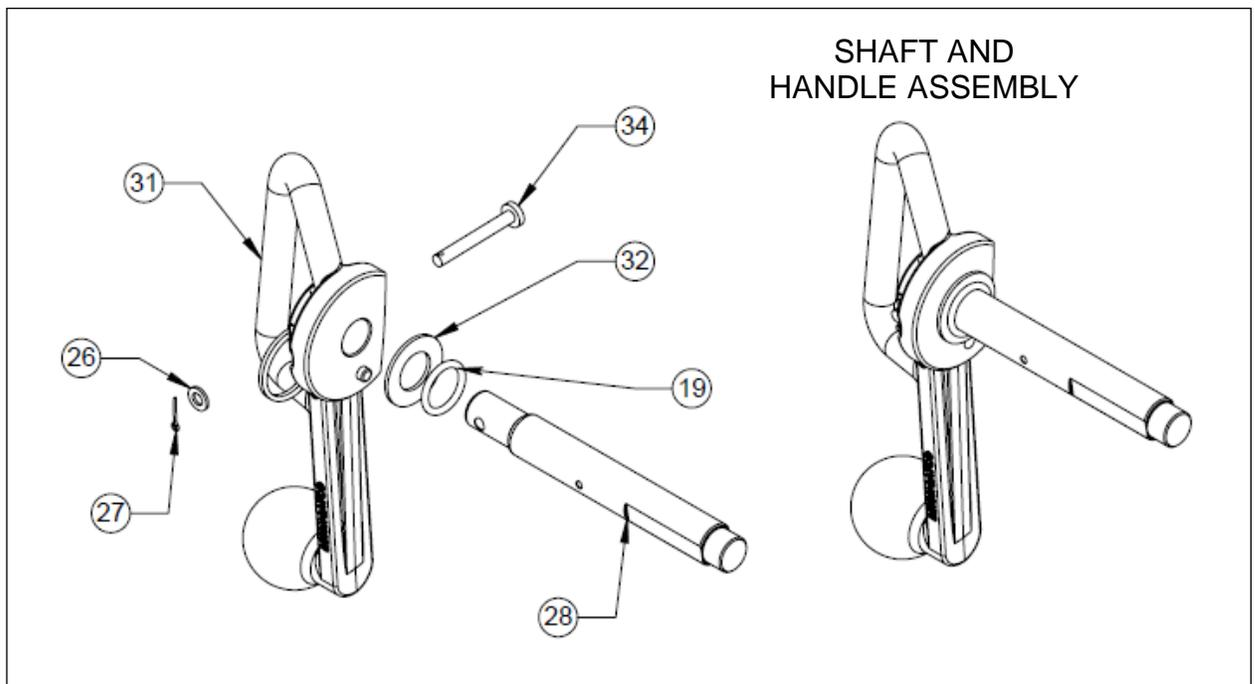
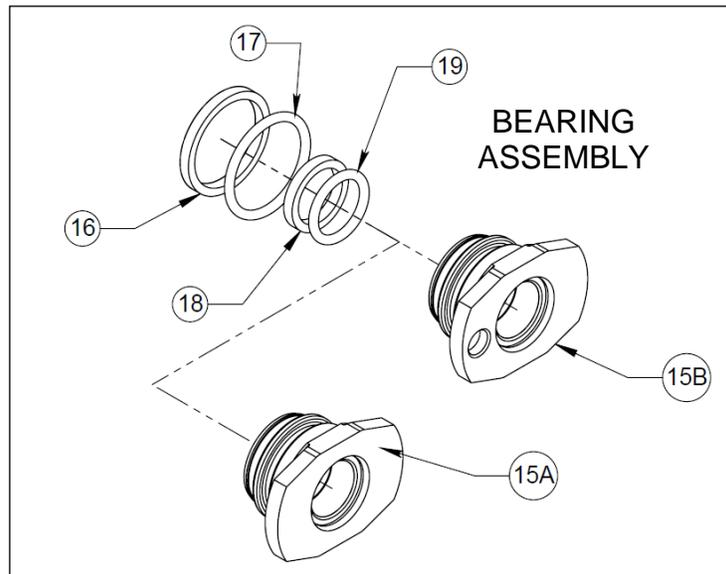
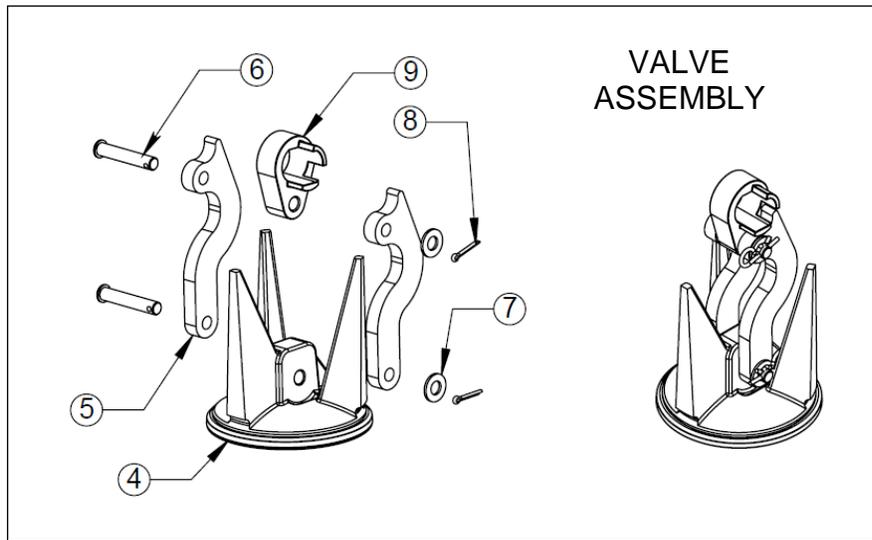

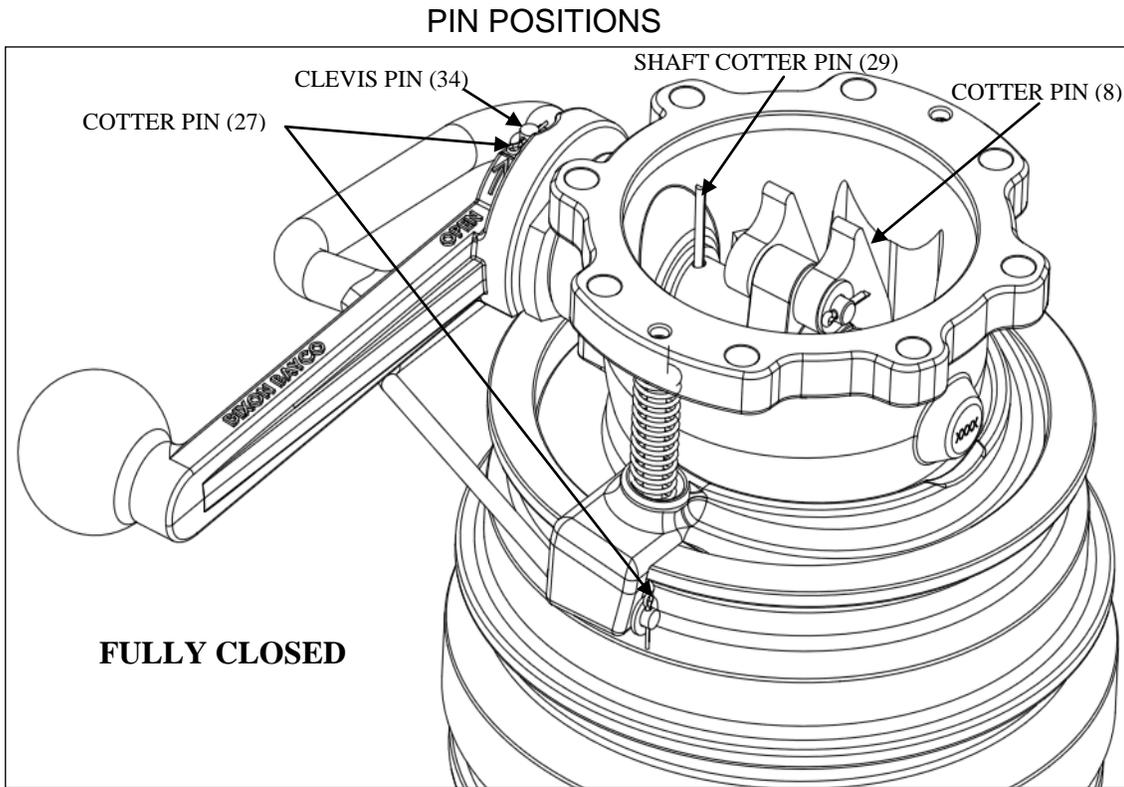
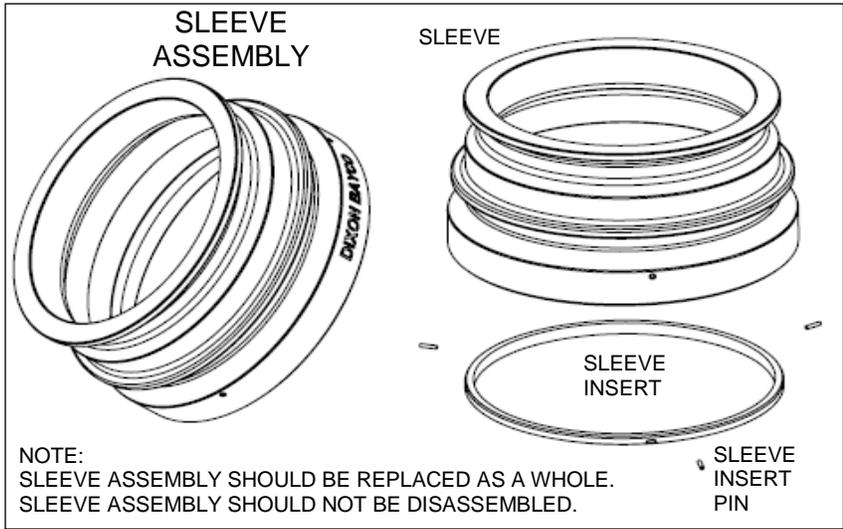
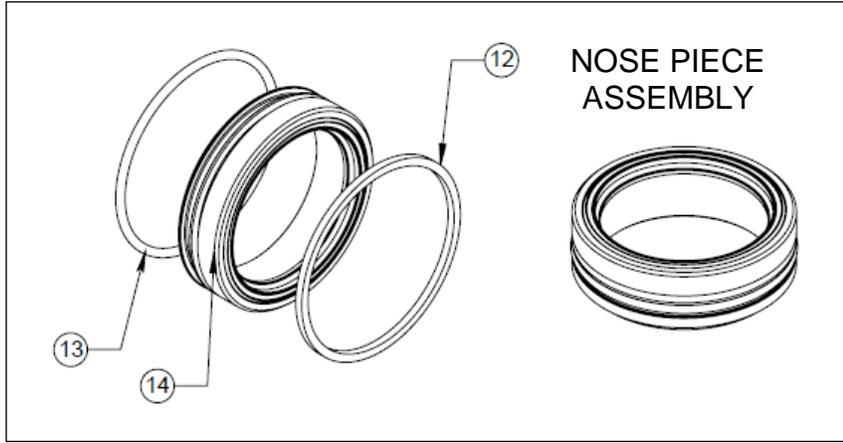

These instructions and recommendations are provided to ensure proper operation and long service life of the Dixon “Bayco” API rack coupler. Parts are identified by the item number on the assembly drawing and part list.

SUGGESTED MAINTENANCE SCHEDULE:

1. MONTHLY INSPECTION

Visual inspection of the API rack coupler operation can be done while the API rack coupler is still on the loading arm. All safety precautions that apply to the use of the API rack coupler must be followed.

While the API rack coupler is still on the loading arm, visually examine the API rack coupler for any worn or damaged parts, such as the body (1), sleeve (3), handle (31), bail (21), poppet (4), nose seal (14), interlocking cams (10), latch (35), flange bolts, etc., or any other condition that may affect the operation of the API rack coupler.

Examine the API rack coupler to make sure that the API rack coupler functions well. See Clause 3 in Section “**INSTALL API RACK COUPLER TO LOADING ARM**” for procedures.

Check the handle (31) for free and easy movement of the opening and closing cycle. Operation of the handle (31) normally requires limited effort. If operating the handle (31) involves stronger force, it implies the need to clean and possibly replace the shaft bearing (15) and the shaft (28).

During service time when the line is filled with liquid product, visually check for evidence of leakage, especially through the shaft seals (16, 17, 18, and 19), nose piece seals (13), nose seal (14) and the flange gasket. Any evidence of leakage means there is a need for further maintenance.

2. YEARLY INSPECTION

For yearly inspection, the API rack coupler should be removed from the loading arm. See Section “**DISMANTLE API RACK COUPLER FROM LOADING ARM**” for procedures of how to dismantle the API rack coupler from the loading arm. See Section “**DISASSEMBLY**” for procedures of how to disassemble the API rack coupler for further maintenance.

It is recommended that all seals (13, 14, 16, 17, 18, and 19) should be inspected every 12 months. Replace any worn or damaged seals. See Section “**REPLACE SEALS**” for procedures.

It is recommended that the valve assembly should be inspected every 12 months. Check the bent links (5), drive link (9) and poppet (4) carefully to make sure that there is no permanent deformation, wear, cracking, or any other damage. Check the bent link pins (6) carefully to make sure there is no permanent deformation such as bending and cracking. Replace any deformed, worn or damaged parts in the valve assembly. See Section “**REPLACE VALVE ASSEMBLY AND PARTS**” for procedures.

Warning: Deformed bent link pins (6), drive link (9) and bent links (5) may cause leakage through poppet (4) seals. Further service of deformed bent link pins (6), drive link (9) and bent links (5) will lead to cracks and breakage, which will cause a complete failure of the API rack coupler.

Visually examine the shaft (28) every 12 months for significant dirt accumulation that could cause shaft seal leakage. Visually examine the shaft (28), shaft inside washer (33), shaft outside washer (32) and handle (31) for wear and damage. Replace any worn or damaged parts.

Visually examine the nose piece assembly every 12 months for significant dirt accumulation that could cause nose piece seal leakage.

Visually examine the body (1), sleeve (3), interlocking cams (10), latch (35) and torsion springs (11) for wear or damage every 12 months. Check the interlocking cam groove on the sleeve (3) for wear and damage. Replace any worn or damaged parts.

Warning: If there is significant wear on the interlocking cam groove of the sleeve (3) or the interlocking cams (10), replace the sleeve (3) or interlocking cams (10) immediately. Failure to replace worn sleeve (3) and interlocking cams (10) can cause failure of interlock, which will result in failure of the API rack coupler.

3. SEAL REPLACEMENT

It is recommended that seals should be replaced with appropriate API rack coupler seal kit every 2 years, or at the first evidence of leakage. See Section “**REPLACE SEALS**” for procedures.

4. OVERHAUL

It is recommended that a complete overhaul of the API rack coupler should be performed every 4 years, or at the first evidence of leakage. Complete overhaul would involve seal inspection and replacement, valve assembly inspection, inspection of body (1), sleeve (3), shaft (28), interlocking cams (10), latch (35) and springs (11, 22). Replace any worn or damaged parts immediately. See corresponding sections for procedures.

CAUTION! WHEN THE API RACK COUPLER POPPET (4) IS UNDER PRESSURE, THE HANDLE (31) OF THE API RACK COUPLER MAY ROTATE VIOLENTLY. PERSONAL INJURIES MAY RESULT IF THIS PRECAUTION IS NOT TAKEN.

INSTALL API RACK COUPLER TO LOADING ARM:

Warning: Read and understand this instruction manual before starting installation.

1. Check the API rack coupler to make sure that there is no damage.
2. Secure the loading arm. Align the TTMA 4” flange of the API rack coupler to the loading arm end flange with TTMA 4” gasket. Insert two bolts into the top bolt holes on the flanges and hand tighten the bolts first. Install the remaining six bolts and tighten all the bolts.
3. Make sure that all other devices for the loading arm are properly installed and ready for use. Make sure that there is no liquid product in the line. Snap the API rack coupler onto an API adapter. Check the followings:
 - Make sure that the nose ring of API adapter is locked by the five interlocking cams (10) of the API rack coupler.
 - Make sure that the sleeve (3) moves fully forward to the outlet of the API rack coupler.
 - If the sleeve (3) is in place, check the interlock by pulling back the API rack coupler or bending the API rack coupler sideways without triggering the release (25). The API rack coupler should be locked tightly.
 - If the API rack coupler is locked tightly, fully rotate the handle (31) to the open position. Make sure that the handle (31) can rotate freely and the poppet (4) of the API rack coupler can push the poppet of the API adapter to the open position.
 - When the poppet (4) of the API rack coupler is in the open position, try to trigger the release (25) to make sure that the sleeve (3) is locked by the interlocking cam surface of the handle (31).
 - Rotate the handle (31) to fully closed position. Trigger the release (25). The sleeve (3) should move back and five interlocking cams (10) should unlock the nose ring of the API adapter. The API rack coupler should be able to be removed from the API adapter.

- If there are problems with any of the above, see the following section to dismantle the API rack coupler from the API adapter and remove the API rack coupler from the loading arm. See Section “**DISASSEMBLY**” for further instructions of how to disassemble the API rack coupler to inspect individual parts. Contact the factory if it is a new API rack coupler.

DISMANTLE API RACK COUPLER FROM LOADING ARM:

Warning: Read and understand this instruction manual before starting installation. Make sure that there is adequate personal protection all the time when dismantling the API rack coupler from the loading arm.

1. Shut off all working devices. Drain the loading arm. Dismantle the API rack coupler when it is clean and dry.
2. Secure the loading arm from movement and support the API rack coupler. Make sure that the API rack coupler is fully closed.
3. Loosen the bolts on the TTMA flange of the API rack coupler. Leave the two top bolts on and remove the remaining six bolts first. And then remove the two top bolts.
4. Remove the API rack coupler from the loading arm. Remove the TTMA gasket between the flanges.

REPLACE VALVE ASSEMBLY AND PARTS:

Note: Valve assembly (poppet assembly) and parts can only be replaced when the API rack coupler is off the rack. The design of the Dixon Bayco API rack coupler shaft (28) makes it easy to remove the valve assembly from the API rack coupler as a whole. This makes it easy to replace the whole valve assembly or any individual part of the valve assembly. There is **NO** need to remove the bent link pin (6) from the bent links (5) while the valve assembly is still in the API rack coupler.

Warning: Carefully handle the poppet (4) without damaging the sealing surface when replacing valve assembly or parts. Even the smallest scratches on the sealing surface can cause leakage.

1. When the API rack coupler is off the rack, **DO NOT** remove the handle cotter pin (27), washer (26) and clevis pin (34) from the shaft (28). When the API rack coupler is closed, remove the shaft cotter pin (29) from the shaft (28) by using pliers.
2. Defeat the interlock manually or use an API adapter nose ring so the sleeve (3) can move fully forward to the outlet of the API rack coupler.
3. Turn the handle (31) to open the API rack coupler.
4. Pull out the shaft and handle assembly with the shaft outside washer (32) and dust O-Ring (19). The valve assembly will fall free of the shaft (28). The spacer (30) and the shaft inside washer (33) will also fall free of the shaft (28).
5. Inspect all parts of the valve assembly. Replace any damaged parts in the valve assembly. When reassembling the valve assembly, make sure the bent links (5) and the drive link (9) are assembled in the same orientation as shown in the valve assembly figure.
6. Assemble the shaft and handle assembly to the body (1) through the bearing (15). Assemble the shaft inside washer (33), the drive link (9) and the spacer (30) before pushing the other end of the shaft (28) into the shaft (28) end pocket on the body (1). Pay attention to the orientation of the valve assembly.
7. Rotate the handle (31) to fully closed position. Rotate handle back 1 turn & install the shaft cotter pin (29) onto the shaft (28).
8. Check the API rack coupler with an API adapter to make sure all components are assembled properly.

REPLACE SEALS:

Warning: Carefully remove and install parts without damaging any sealing surfaces when replacing seals. Even the smallest scratches on the O-Ring groove or other sealing surface will cause leakage.

Note: Remove any burrs and sharp edges that could damage the seals during reassembly.

There are different ways that seals can be replaced in the API rack coupler.

Replace shaft seals in stuffing box while API rack coupler is still on the rack

Note: This is a standard feature of Dixon Bayco the API rack coupler. Shaft seals (16, 17, 18, and 19) can always be replaced while the API rack coupler is still on the rack.

1. Shut off all working devices. Drain the loading arm. Only replace the API rack coupler shaft seals when the API rack coupler is clean and dry.
2. Defeat the interlock manually or use an API adapter nose ring so the sleeve (3) can move fully forward to the outlet of the API rack coupler.
3. Turn the handle (31) to open the API rack coupler.
4. Remove the handle cotter pin (27), the washer (26) and the clevis pin (34).
5. Remove the handle (31), the shaft outside washer (32), the dust O-Ring (19) from the shaft (28) end.
6. Remove the bearing assembly from the stuffing box by pulling it out with your hands. When pulling the bearing assembly, loosen the bearing assembly by twisting the flange of the bearing (15). If needed, use flat screw drivers from the back of the flange of the bearing (15) to loosen the bearing assembly. Make sure not to damage the body (1).
7. Remove the O-Rings (17, 19) and the u-seals (16, 18, optional) from the bearing assembly, inspect for any wear or damage. Make sure not to damage the bearing (15) or scratch sealing surfaces.
 - If the bearing (15) is good, thoroughly clean the bearing (15) to remove any debris, oil and grease. Lubricate NEW O-Rings (19 for inside groove and 17 for outside groove). Install the new O-Rings (17, 19) into the grooves. If u-seals (16, 18) are ordered, lubricate NEW u-seals (18 for inside groove and 16 for outside groove). Install the new u-seals (16, 18) into the grooves. Handle the u-seals (16, 18) carefully and make sure not to damage the u-seals (16, 18).
 - If the bearing (15) is already damaged or has scratches on the sealing surfaces, replace the bearing assembly with a NEW bearing assembly, which includes the bearing (15), the inside O-Ring (19), the outside O-Ring (17), the inside u-seal (18, optional) and the outside u-seal (16, optional).
8. Apply grease on the bearing (15) and install the bearing assembly into the stuffing box by pushing with your hands through the shaft (28) end.
9. Assemble the **NEW** dust O-Ring (19), the **NEW** shaft outside washer (32) and the handle (31). Replace the handle (31) if it is damaged.
10. Assemble the clevis pin (34), the washer (26) and the handle cotter pin (27). Replace with a new part if any of these are worn or damaged.
11. Check the API rack coupler with an API adapter to make sure all components are assembled properly.

Replace shaft seals in stuffing box while API rack coupler is off the rack

Note: Shaft seals (16, 17, 18, and 19) can always be replaced while the API rack coupler is still on the rack. While the API rack coupler is off the rack, shaft seals (16, 17, 18, and 19) can be replaced in the same way while the API rack coupler is on the rack. See Section “**Replace shaft seals in stuffing box**”

while API rack coupler is still on the rack” for procedures. While the API rack coupler is off the rack, shaft seals (16, 17, 18, and 19) can also be replaced using the method described here.

1. When the API rack coupler is off the rack, **DO NOT** remove the handle cotter pin (27), the washer (26) and the clevis pin (34) from the shaft (28). When the API rack coupler is closed, remove the shaft cotter pin (29) from the shaft (28) by using pliers.
2. Defeat the interlock manually or use an API adapter nose ring so the sleeve (3) can move fully forward to the outlet of API rack coupler.
3. Turn the handle (31) to open the API rack coupler.
4. Pull out the shaft and handle assembly with the shaft outside washer (32) and dust O-Ring (19). The valve assembly will fall free of the shaft (28). The spacer (30) and the shaft inside washer (33) will also fall free of the shaft (28).
5. Remove the bearing assembly from the stuffing box by pulling it out with your hands. When pulling the bearing assembly, loosen the bearing assembly by twisting the flange of the bearing (15). If needed, use flat screw drivers from the back of the flange of the bearing (15) to loosen the bearing assembly. Make sure not to damage the body (1).
6. Remove the O-Rings (17, 19) and the u-seals (16, 18, optional) from the bearing assembly and make sure not to damage the bearing (15) or scratch sealing surfaces.
 - If the bearing (15) is good, thoroughly clean the bearing (15) to remove any debris, oil and grease. Lubricate NEW O-Rings (19 for inside groove and 17 for outside groove). Install the new O-Rings (17, 19) into the grooves. If u-seals (16, 18) are ordered, lubricate NEW u-seals (18 for inside groove and 16 for outside groove). Install the new u-seals (16, 18) into the grooves. Handle the u-seals (16, 18) carefully and make sure not to damage the u-seals (16, 20).
 - If the bearing (15) is already damaged or has scratches on the sealing surfaces, replace the bearing assembly with a NEW bearing assembly, which includes the bearing (15), the inside O-Ring (19), the outside O-Ring (17), the inside u-seal (18, optional) and the outside u-seal (16, optional).
7. Apply grease on the bearing (15) and install the bearing assembly into the stuffing box by pushing with your hands.
8. Replace the shaft outside washer (32) and dust O-Ring (19) with **NEW** ones on the shaft (28).
9. Assemble the shaft and handle assembly with the shaft outside washer (32) and dust O-Ring (19) to the body (1) through the bearing (15). Assemble the shaft inside washer (33), the drive link (9) and the spacer (30) before pushing the other end of the shaft (28) into the shaft (28) end pocket on the body (1). Pay attention to the orientation of the valve assembly.
10. Rotate the handle (31) to fully closed position. Install the shaft cotter pin (29) onto the shaft (28).
11. Check the API rack coupler with an API adapter to make sure all components are assembled properly.

Replace the seals on the nose piece while API rack coupler is off the rack

Note: Nose piece seals, including O-Ring (13) and nose piece dust ring (12) can only be replaced when the API rack coupler is off the rack. Bonded nose seal (14) can only be replaced by replacing the nose piece assembly.

1. When the API rack coupler is off the rack, **DO NOT** remove the handle cotter pin (27), the washer (26) and the clevis pin (34) from the shaft (28). When the API rack coupler is closed, remove the shaft cotter pin (29) from the shaft (28) by using pliers.
2. Defeat the interlock manually or use an API adapter nose ring so the sleeve (3) can move fully forward to the outlet of the API rack coupler.
3. Turn the handle (31) to open the API rack coupler.

4. Pull out the shaft and handle assembly with the shaft outside washer (32) and dust O-Ring (19). The valve assembly will fall free of the shaft (28). The spacer (30) and the shaft inside washer (33) will also fall free of the shaft (28).
5. Remove the nose piece assembly, which includes nose seal (14), O-Ring (13), nose piece dust ring (12). Remove the wave spring washers (22). Replace the whole nose piece assembly with a new one.
6. Assemble the wave spring washers (20) and nose piece assembly.
7. Assemble the shaft and handle assembly with the shaft outside washer (32) and dust O-Ring (19) to the body (1) through the bearing (15). Assemble the shaft inside washer (33), the drive link (9) and the spacer (30) before pushing the other end of the shaft (28) into the shaft (28) end pocket on the body (1). Pay attention to the orientation of the valve assembly.
8. Rotate the handle (31) to the fully closed position. Install the shaft cotter pin (29) onto the shaft (28).
9. Check the API rack coupler with an API adapter to make sure all components are assembled properly.

DISASSEMBLY:

Warning: Carefully remove parts without damaging any sealing surfaces when disassembling the API rack coupler. Even the smallest scratches on the O-Ring grooves or other sealing surfaces will cause leakage.

1. When the API rack coupler is off the rack and fully closed, remove the shaft cotter pin (29) from the shaft (28) by using pliers.
2. Defeat the interlock manually or use an API adapter nose ring so the sleeve (3) can move fully forward to the outlet of the API rack coupler.
3. Turn the handle (31) to fully open the API rack coupler. Pull out the shaft and handle assembly with shaft outside washer (32) and dust O-Ring (19). The valve assembly will fall free of the shaft (28). The spacer (30) and the shaft inside washer (33) will also fall free of the shaft (28).
 - To completely disassemble the shaft and handle assembly, remove the handle cotter pin (27), the washer (26) and the clevis pin (34). Remove the handle (31), the shaft outside washer (32), the dust O-Ring (19) from the shaft (28) end.
 - To completely disassemble the valve assembly, remove the bent link cotter pins (8), bent link washers (7) and bent link pins (6).
4. Remove the bearing assembly from the stuffing box simply by pulling it out with your hands. If needed, use flat screw drivers from the back of the flange of the bearing (15) to help the bearing assembly out.
5. To completely disassemble the bearing assembly, remove O-Rings (17, 19) and u-seals (16, 18, optional) from the bearing (15).
6. Remove cotter pins (27) and washers (26) from the release (25) ends. Remove the release (25) from the bail (21).
7. Remove the retaining rings from the bail pins (23) by screw drivers or pointers.
8. Turn the API rack coupler upside down and the bail pins (23) will fall out. If the bail pins (23) do not fall out, move the bail springs (24) until the bail pins (23) fall out.
9. Remove the bail springs (22) and the bail (21).
10. Remove the sleeve (3) from the body (1) by pulling the sleeve (3) to the inlet of the body (1).
11. Remove the five interlocking cams (10) from the body (1). Remove the latch (37) from the body. Remove the six torsion springs (11) from the body (1). Remove the body dust ring (2) from the body (1).
12. Remove the nose piece assembly. If needed, use a screw driver and a hammer to push the wave spring washers (20) from the body (1) inlet to help the nose piece assembly out. Remove the wave spring washers (20).

Warning: Use the screw driver and hammer to push the wave spring washers (20) only. Do not use the screw driver and hammer to push the nose seal (14) out from the inlet of the body (1). This will damage the nose seal (14) surface. To completely disassemble the nose seal assembly, remove the O-Ring (13), nose piece dust ring (12).

ASSEMBLY:

1. Assemble the bearing assembly if it is disassembled. See Section “**Replace shaft seals in stuffing box while API rack coupler is still on the rack**” for procedures of how to assemble the bearing assembly.
2. Assemble the valve assembly if it is disassembled. See Section “**REPLACE VALVE ASSEMBLY AND PARTS**” for procedures of how to assemble the valve assembly.
3. Assemble the nose piece assembly if it is disassembled. See Section “**Replace the seals on the nose piece while API rack coupler is off the rack**” for procedures of how to assemble the nose piece assembly.
4. Assemble the shaft and handle assembly if it is disassembled. Install the dust O-Ring (19), shaft outside washer (32), handle (31), clevis pin (34), washer (26) and handle cotter pin (27) to the shaft (28).
5. Install the body dust ring (2) to the body dust groove.
6. Install the torsion springs (11), the latch (35) and the interlocking cams (10) to the body (1).
7. Install the wave spring washers (20) and the nose piece assembly to the body (1).
8. Install the sleeve (3) to the body (1). Push in the five interlocking cams (10) manually so the sleeve (3) can move fully forward to the outlet of the API rack coupler. Use nose ring of API adapter or ask others for assistance.
9. Install the bearing assembly into the stuffing box by pushing with your hands.
10. Install the shaft and handle assembly to the body (1) through the bearing (15). Assemble the shaft inside washer (33), the drive link (9) of the valve assembly and the spacer (30) before pushing the other end of the shaft (28) into the shaft (28) end pocket on the body (1). Pay attention to the orientation of the valve assembly.
11. Rotate the handle (31) to fully closed position. Install the shaft cotter pin (29) onto the shaft (28).
12. Install the bail (21), bail springs (22), bail pins (23) and internal retaining rings (24) to the body (1).
13. Install the release (25) to the bail (21). Install the washers (27) and cotter pins (27) to the ends of release (25).
14. Rotate the handle (31) to the open position and closed position several times to verify proper operation.
15. When the handle (31) is in the closed position, trigger the release (25) so the sleeve (3) can move fully backward to lock the handle (31). The API rack coupler should not be able to be opened by rotating the handle (31).
16. Check the API rack coupler with an API adapter to make sure all components are assembled properly.
Warning: If the sleeve subassembly (3) and interlocking cams (10) are disassembled and replaced, try coupling and uncoupling the API rack coupler to an API adapter nose ring a few times making sure the locking mechanism functions well before putting the API rack coupler back onto the loading arm.

DIXON WARRANTY:

For Warranty Information, please refer to the inside back cover of the latest Dixon Catalogue.